

Big Dutchman®



Dry Rapid, **EcoMatic** *pro*, **DryExact** *pro*

The versatile and efficient dry feeding systems for experts

DryRapid DR 1500 & DR 6500

Efficient pipe conveying systems

Whenever dry feed, be it mash, crumbles or pellets, has to be conveyed or distributed on a pig farm, Big Dutchman's DryRapid is the ideal transport system – from the silo discharge all the way to the feed trough. This efficient pipe

conveying system is available as DR 1500 with a conveying capacity of up to 1500 kg/h. DryRapid can be controlled either by the DryRapid 103 controller or with our management and control system BigFarmNet.

For large amounts of cereal and feed, Big Dutchman can additionally offer the DR 6500 with a conveying capacity of up to 6500 kg/h.

Options for using DryRapid

In sow houses:

- ✓ individual sow feeding with volume dispensers
- ✓ supply of the ESF system for pregnant sows that are kept in groups

In nurseries and finishing houses:

- ✓ supply of all types of self-feeders
- ✓ as conveying unit of the computer-controlled dry feeding systems EcoMaticpro and DryExactpro

As conveying system:

- ✓ supply of multiple silos from one main silo with DR 6500



Use of volume dispensers to feed sows kept in individual stalls



Call-Innpro for pregnant sows kept in groups



Use of DryExactpro for piglet rearing



Supply of PigNic feeders in a finishing pen

Advantages of DryRapid

- ✓ DryRapid is a versatile system and therefore ideally suited for the modernisation of existing barns;
- ✓ feed can be taken directly from the silo, i.e. additional feed augers are not required;
- ✓ an upgrade to a computer-controlled feeding system is possible at any time;
- ✓ high conveying capacity;
- ✓ smooth feed transport with minimum losses;
- ✓ the filling level can be adjusted separately for all feeders by means of a telescopic drop pipe;
- ✓ low maintenance requirements and long service life.

Main components

Drive unit

- ✓ compact design, can be installed either inside or outside the barn;
- ✓ has a stainless steel housing;
- ✓ can be equipped with a tensioning device (optional);
- ✓ drive unit XXL is available for longer transport distances;
- ✓ special drive wheel (optional) made of elastic plastic (PUR) and with a sickle-shape cog profile for better power transmission and reduced wear of the chain: more cogs pull the chain and the load on the individual carrier discs is lower;
- ✓ a weather guard (optional) protects the drive unit from the weather if it is installed outside the barn.

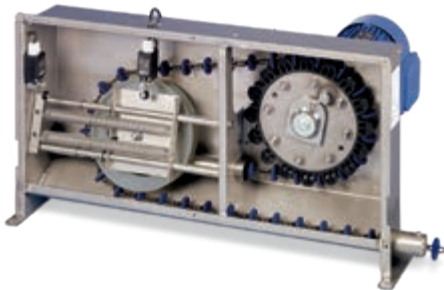

Standard drive wheel



Drive wheel made of orange polyurethane

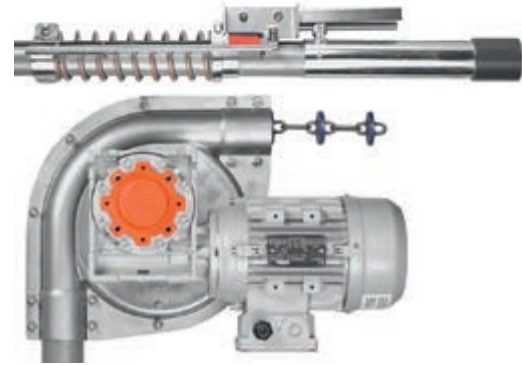

Corner drive with tensioning device

Feed hopper

- ✓ made of stainless steel and installed in the barn or directly beneath the silo;
- ✓ conveying capacity can be adjusted continuously by means of a shut-off;
- ✓ available with one or two lines to supply two circuits, if necessary;
- ✓ can be supplied with a mechanical or motor-driven forced infeed and a forced return for uniform filling of the feed pipe to prevent overflowing of the system.



Conveying pipe with conveyor chain

- ✓ conveying pipe is made of galvanized steel and has an outer diameter of 60 mm;
- ✓ pipe is optionally also available made of stainless steel or with a novel Magnelis® coating (a special Zn-Al-Mg alloy offering superb protection against corrosion in environments containing ammonia);
- ✓ chain is made of custom-hardened steel;
- ✓ carrier discs are made of high-quality plastic with diameters of 49 and 42 mm;
- ✓ carrier discs are injection-moulded to the chain in a way that all chain links remain free and only very small quantities of feed are entrained.

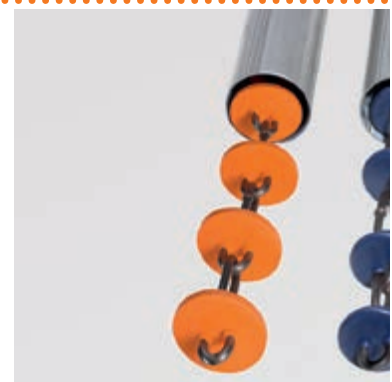

90° corner

- ✓ corner housing is made of plastic or stainless steel or is galvanized; a transparent cover is also available;
- ✓ all corners are non-corrosive and therefore well-suited for outside and inside installation;
- ✓ ball-bearing corner wheel made of plastic or cast iron for reduced friction in the 90° corner;
- ✓ easy transport of mash, crumbles and pellets.



Corner wheel made of cast iron



Corner housing made of stainless steel

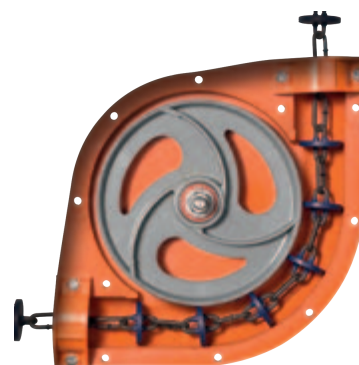

Corner wheel made of plastic

Outlet with shut-off

- ✓ supplies all types of self-feeders;
- ✓ made of plastic;
- ✓ with shut-off, available in two colours for easy distinction between two feed circuits;
- ✓ can be equipped with a rigid or telescopic drop pipe, both also available as transparent version.



Pneumatic feed valve

- ✓ necessary when using the computer-controlled dry feeding systems *EcoMatic^{pro}* and *DryExact^{pro}*;
- ✓ installation at the conveying pipe at an angle of up to 30° to reduce the number of feed lines;
- ✓ can be controlled directly at the valve or by a valve terminal in the central aisle;
- ✓ shut-off can be supplied as plastic or metal version;
- ✓ labyrinth seal prevents incorrect dosing;
- ✓ large opening reduces the risk of feed entrainment.



Control via valve terminal in the central aisle

Control directly at the feed valve

Our proven 90°
corner ensures
reliable feed
recirculation.



Volume dispensers

- ✓ stepless dispensing for individual sow feeding;
- ✓ transparent hopper with a capacity of 6 or 8 litres;
- ✓ easy-to-read adjustment markings indicate litres and kilogrammes;
- ✓ large opening makes adding feed additives easy;
- ✓ clip for data sheets so important information about the sow is always within reach.

Volume dispenser BD

- ✓ minimum amount approx. 1 litre;
- ✓ good price/performance ratio.

Volume dispenser Vario

- ✓ minimum amount approx. 1 litre;
- ✓ lower part of the volume dispenser is easy to open for thorough cleaning;
- ✓ central and off-set suspension options provide a good overview for the staff.



Volume dispenser BD 8 L and 6 L



Volume dispenser Vario 6 L and 8 L

Release station for volume dispenser

- ✓ manual release by means of a cable winch;
- ✓ automatic release with a pneumatic drive for up to 30 volume dispensers;
- ✓ automatic release with a 24 V or a 230 V drive for up to 100 volume dispensers.



Pneumatically operating release station



Electrically operating release station with 24 V drive unit



Electrically operating release station with 230 V drive unit

Dispensers for small quantities

- ✓ precise addition of pulverised feed additives to the dry feed;
- ✓ diseases in the pig house can be treated immediately and at a low price;
- ✓ can easily be retrofitted into existing pipe conveying systems.

1. Small quantity dosing device MediPut

- ✓ large dosing range from 0.25 kg to 10 kg of additive per tonne of feed;
- ✓ precise metering even with fluctuating amounts;
- ✓ no dispensing when the silo is empty or in case of feed bridging;
- ✓ certified according to DIN 10529-1.



Small quantity dosing device MediPut

2. Small quantity dosing device BD

- ✓ dosing range between 400 and 8000 g/h allows time-dependent dispensing.



Small quantity dosing device BD

Sensor

- ✓ switches DryRapid off when the last volume dispenser or the last feeder has been filled.



DryRapid controller 103

- ✓ features the following functions:
 - control of up to two feed circuits;
 - setting of up to 20 feeding times for each circuit;
 - silo selection with replacement components;
 - control of the small quantity dosing device's motor;
 - direct control of the volume dispensers' release station;
 - control of lighting.
- ✓ data can be saved on a USB flash drive;
- ✓ feed review for up to 15 days;
- ✓ updates via USB flash drive.



Technical data of DryRapid

Type		DryRapid 1500	DryRapid 6500
Drive power	kW	1.5	5.5
Chain speed	m/min	27	42
Conveying capacity*	kg/h	up to 1500**	up to 6500
Max. conveying length with 4 corners	m	300 (standard) 450 (XXL drive)	300 -

* at a filling level of 66 % and a feed density of 650 kg/m³

** in case of forced infeed, the capacity may vary depending on the feed texture

BigFarmNet unites all applications of your farm in *one* software and *one* database. Your advantages:

1. **Always up-to-date: keep track of everything**
Use any of your computers or your smartphone to make inputs – directly in the barn, while you are relaxing at home or even from different farms. All **BigFarmNet** components update and synchronise automatically, and in real time.
2. **Everything in one software – comfortable and fast**
One software unites all applications: the computer-controlled dry feeding systems EcoMatic^{pro} and DryExact^{pro} as well as other applications such as ESF systems, sorting scales, climate control and silo and alarm management. This means that you need to input any information only once.
3. **More security**
Your entire production is recorded in one single software, which also means that all systems are backed up automatically and all alarms are managed centrally. Centralised data input and uniform user interfaces reduce the risk of incorrect inputs.
4. **Optimised production results and reduced costs**
Improve your production results by using efficient analytical tools, and save time and avoid errors thanks to optimised processes.
5. **Reliable and future-proof**
Benefit from the fact that all **BigFarmNet** applications are thoroughly tested in the field and continuously further developed by Big Dutchman.
6. **Only buy what you need**
It does not matter whether you have a large farm complex or a smaller, family-owned farm: **BigFarmNet** meets any requirement and grows with your needs.



In the barn

with our controllers

- Control your systems directly in the barn

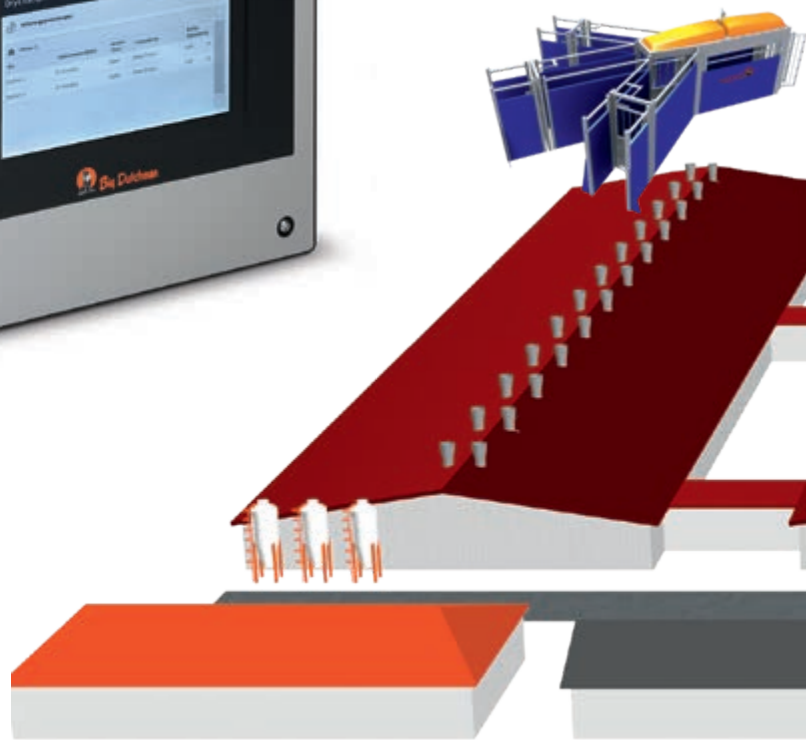

In the office

with BigFarmNet Manager on the PC

- Control, manage and analyse, with graphs and tables
- Animal-based farm management, e.g. evaluation of the entire finishing period



Anywhere you are

with the BigFarmNet app

- Confirm alarms
- View current data
- Optimise livestock management

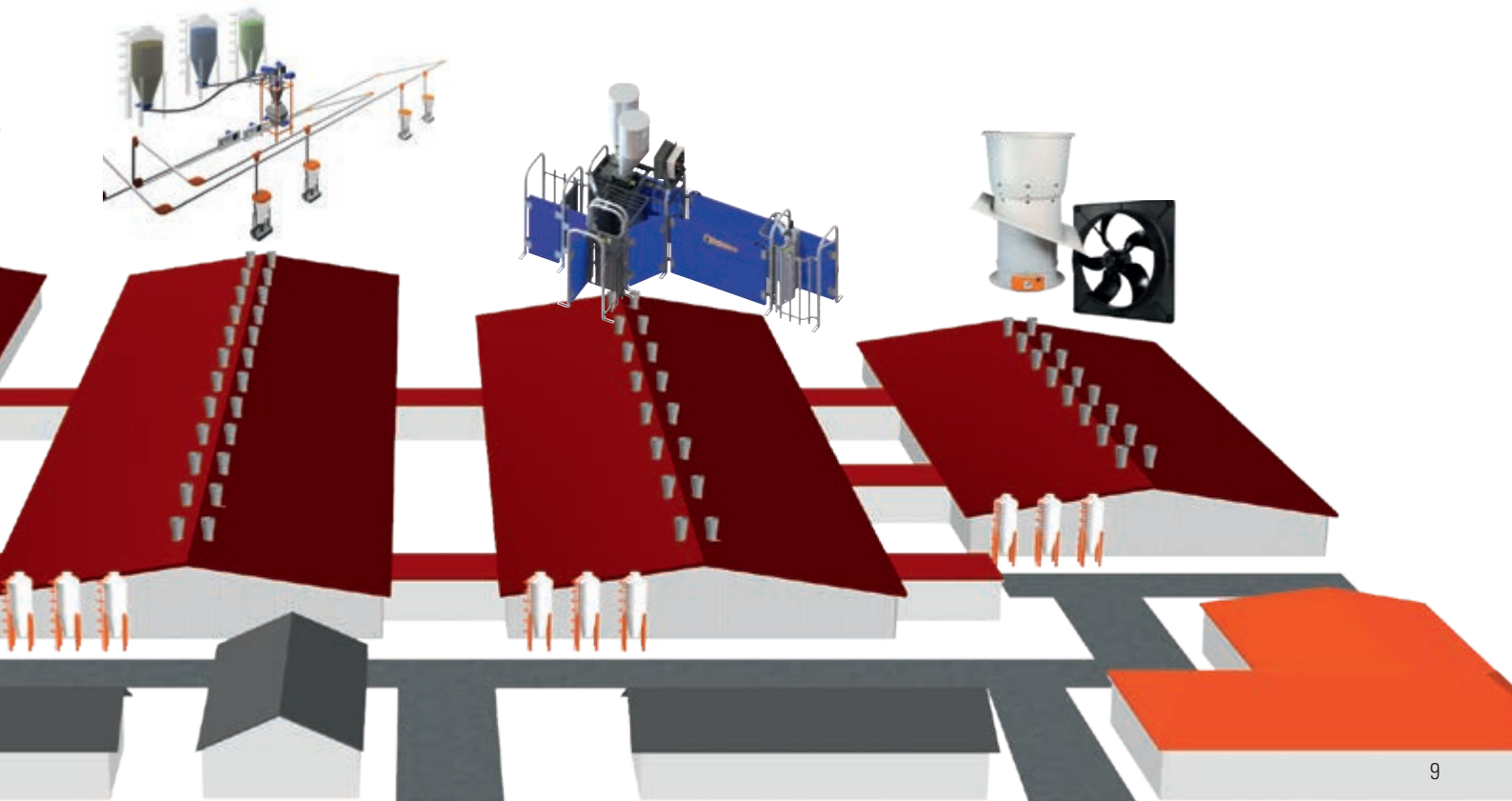

EcoMatic^{pro} – volume-based dispensing of feed

EcoMatic^{pro} supplies feed based on volume. The individual ingredients have to be metered only once. An individual feed mix can be prepared for each feed valve. EcoMatic^{pro} does not need a mixer, distribution unit or feed kitchen. The system is cost-efficient and especially well-suited for high stock numbers. It is controlled by the 510 control computer.

After feeding has started, the individual ingredients are dispensed into the conveying pipe based on volume. To make this possible, a frequency-controlled auger is situated in the feed hopper beneath each silo and dispenses the required amounts of the individual ingredients into the DryRapid conveying pipe. Alternatively, a frequency-controlled FlexVey (flexible spiral) is installed directly beneath the silo. The ingredients are mixed to create the correct recipe, and this feed mix is then dispensed in portions by the valves.

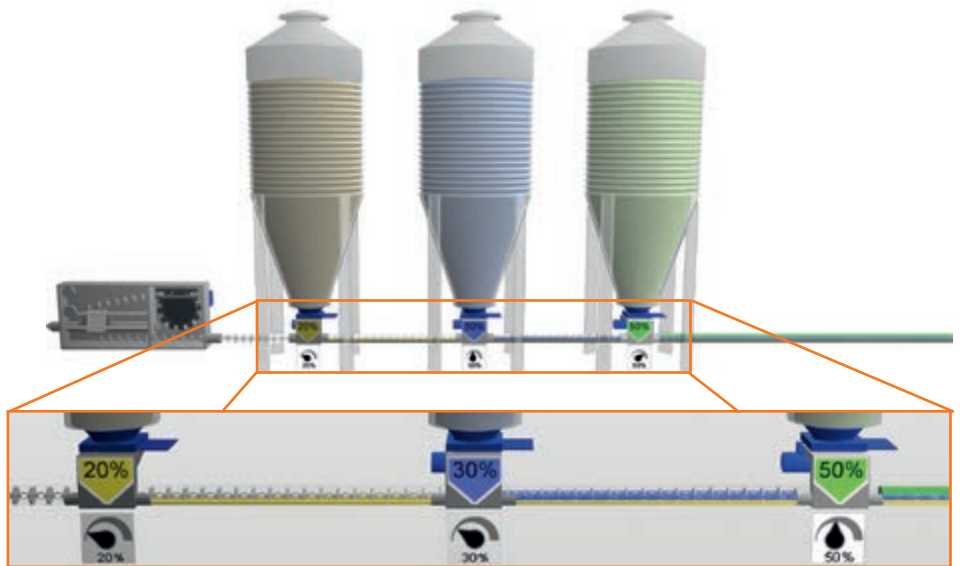

How EcoMatic^{pro} works

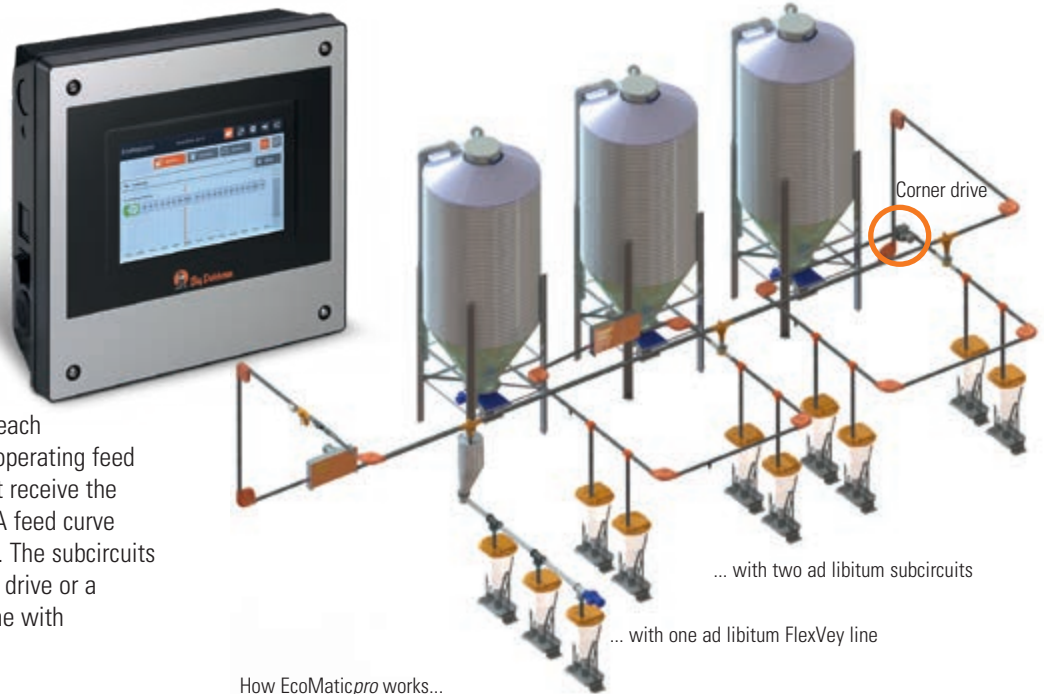

With ad libitum feeding, Big Dutchman offers a cost-efficient feeding method: each circuit requires just *one* pneumatically operating feed valve. Animals being fed by a subcircuit receive the corresponding main circuit's feed mix. A feed curve allows making changes to the feed mix. The subcircuits can be equipped with either a standard drive or a corner drive. Alternatively, a FlexVey line with intermediate tanks can be used.

How EcoMatic^{pro} works...



EcoMatic^{pro} with two main feed circuits

DryExact^{pro} – weight-based dispensing of feed

The DryExact^{pro} system works with a weighed batch mixer that has a capacity of 70 litres. This makes it possible to supply an individual feed mix to every valve, and with a very high mixing quality and accuracy. The system is controlled by the 510 control computer.

After feeding has started, the weighed batch mixer is filled with different ingredients. The finished mix drops into a hopper with funnel below the mixer or, in case of a two-line circuit, into a container (tilting box) that supplies feed alternately to both circuits. DR 1500 transports the mix to the respective feed valve while the next recipe is already being prepared in the mixer. A sensor inside the feed hopper verifies that the hopper is empty to prevent intermixing of the individual feed recipes. This process is repeated until all valves have been supplied with feed.



How DryExact^{pro} works with two feed circuits



DryExact^{pro} feed kitchen: two systems with one circuit each



DryExact^{pro} with two feed circuits

Advantages of EcoMatic^{pro} and DryExact^{pro}

- ✓ individual feed mix for each valve;
- ✓ every feed valve allows multi-phase feeding to feed pigs based on their age and to save on feed costs;
- ✓ can be upgraded to become a sensor feeding system (option): each hopper is equipped with a sensor that informs the computer of any empty hopper when feeding starts;
- ✓ automatic recording of feed consumption per pen or per room;
- ✓ ad libitum subcircuits as cost-efficient feeding method.

UniScale – the universal silo scale

With UniScale, Big Dutchman can offer a silo scale that allows you to measure and control the contents of your silos absolutely accurately. UniScale is available as a stand-

alone solution or as a BigFarmNet application. It can be supplied with and without display and is ideally suited for outside installation directly at the silo (protection rating IP 66/67).

Delivery checks are easily carried out: especially the version with display quickly provides an overview of your silo's filling levels. Each scale can weigh up to four silos.



Cover for silo foot for accurate weighing even in extreme weather



Silo weighing with UniScale

SiloCheckpro – registering and monitoring silo contents



If you already use BigFarmNet on your farm, SiloCheckpro is a clever additional application that registers, monitors and evaluates the contents and consumptions for your silos. From the PC in your office or at home, you can comfortably check your silos' filling levels and order the next delivery from the feed supplier at the right time.

Which functions does SiloCheckpro provide?

- ✓ filling levels are shown in kilogrammes and percentages;
- ✓ a warning is given when filling levels fall

- below the minimum;
- ✓ the total consumption per silo is indicated;
- ✓ consumption history for each silo;
- ✓ overview of delivered and removed amounts for each silo;
- ✓ network via cables or wireless;
- ✓ the electronic load cells of all silos are connected, even if they are situated at different locations.



Big Dutchman.

Europe, Middle East & Africa:
Big Dutchman International GmbH
 P.O. Box 1163 - 49360 Vechta, Germany
 Tel. +49(0)4447 801-0 · Fax -237
 big@bigdutchman.de
 www.bigdutchman.de

USA: Big Dutchman, Inc.
 Tel. +1 616 392 5981 · bigd@bigdutchmanusa.com
 www.bigdutchmanusa.com

Brazil: Big Dutchman (Brasil) Ltda.
 Tel. +55 16 2108 5310 · bdb@bigdutchman.com.br
 www.bigdutchman.com.br

Russia: 000 "Big Dutchman"
 Tel. +7 495 229 5161 · big@bigdutchman.ru · www.bigdutchman.ru

Asia/Pacific: BD Agriculture (Malaysia) Sdn. Bhd.
 Tel. +60 33 34 83 555 · bdasia@bigdutchman.com · www.bigdutchman.com

China: Big Dutchman (Tianjin) Livestock Equipment Co., Ltd.
 Tel. +86 10 5632 0188 · bdcnsales@bigdutchman.com
 www.bigdutchmanchina.com

